

Data Sheet



Article number: 0125069

Description: Retaining ring SP52
Spring steel

Measures

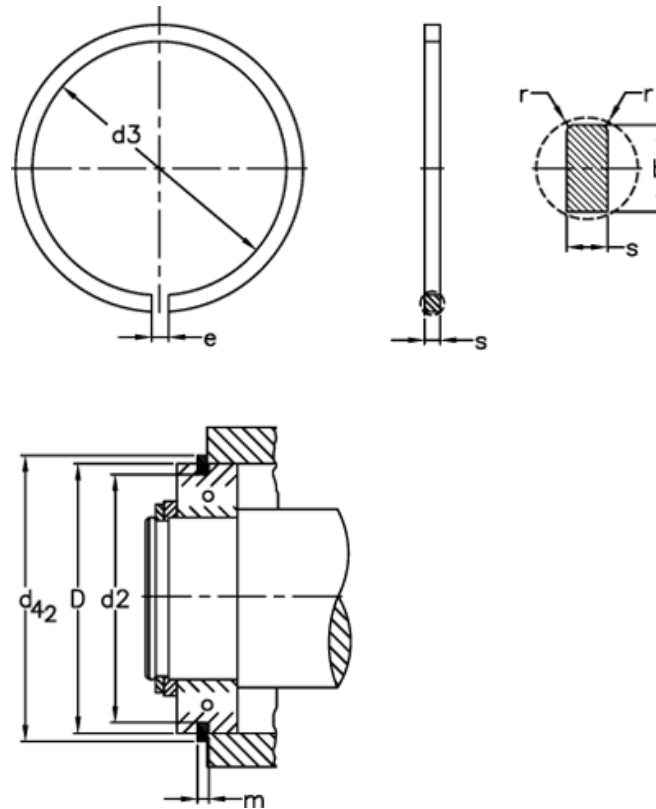

b	= 4.04	FRg kN	= 2.01	tol	= -0.15
D	= 52	FR kN	= 12.8	tol	= -0.1
d2	= 49.73	g	= 2.5	tol	= -0.25
d3	= 48.8	K kN-mm	= 23.4	tol	= 0.3
d42	= 57.9	m	= 1.35	tol	= 0.5
Description	= SP 52	n abl x 1000	= 6.0	Weight kg/1000	= 5.9
e	= 4	r min	= 0.4		
FN kN	= 31.6	s	= 1.12		